

(Apply the label from warranty here)

**SERVICE**

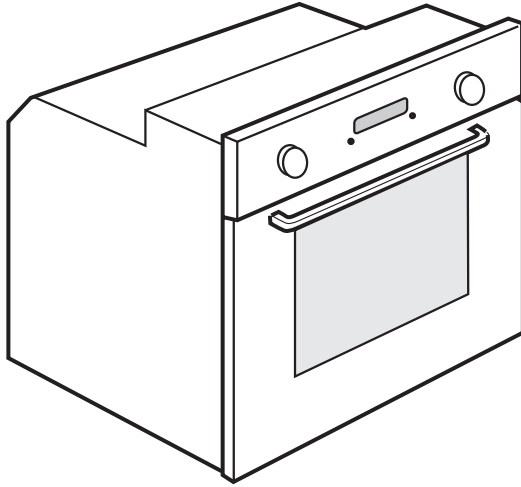

0000 000 00000



**EN**

**User and maintenance manual**



## IMPORTANT SAFETY INSTRUCTIONS

These instructions shall also be available on website: [www.whirlpool.eu](http://www.whirlpool.eu)

### **YOUR SAFETY AND THAT OF OTHERS IS VERY IMPORTANT**

This manual and the appliance itself provide important safety warnings, to be read and observed at all times.

 This is the danger symbol, pertaining to safety, which alerts users to potential risks to themselves and others. All safety warnings are preceded by the danger symbol and the following terms:

 **DANGER** Indicates a hazardous situation which, if not avoided, will cause serious injury.

 **WARNING** Indicates a hazardous situation which, if not avoided, could cause serious injury.

All safety warnings give specific details of the potential risk present and indicate how to reduce risk of injury, damage and electric shock resulting from improper use of the appliance. Carefully observe the following instructions:

- Use protective gloves to perform all unpacking and installation operations.
- The appliance must be disconnected from the power supply before carrying out any installation work.
- Installation and maintenance must be carried out by a qualified technician, in compliance with the manufacturer's instructions and local safety regulations. Do not repair or replace any part of the appliance unless specifically stated in the user manual.
- Power cable replacement must be carried out by a qualified electrician. Contact an authorized service centre.
- Regulations require that the appliance is earthed.
- The power cable must be long enough for connecting the appliance, once fitted in its housing, to the main power supply.
- For installation to comply with current safety regulations, an allpole disconnect switch with minimum contact gap of 3 mm must be utilized.
- Do not use multiple plug adaptors if the oven is fitted with a plug.
- Do not use extension leads.
- Do not pull the power supply cable.
- The electrical components must not be accessible to the user after installation.
- If the surface of the induction plate is cracked, do not use it and switch off the appliance to avoid the possibility of electric shock (only for models with induction function).
- Do not touch the appliance with any wet part of the body and do not operate it when barefoot.
- This appliance is designed solely for use as a domestic appliance for cooking food. No other type of use is permitted (e.g.: heating rooms). The Manufacturer declines all responsibility for inappropriate use or incorrect setting of the controls.

- The appliance and its accessible parts become hot during use. Care should be taken to avoid touching heating elements. Very young (0-3 years) and young children (3-8 years) shall be kept away unless continuously supervised.
- Children from 8 years and above and persons with reduced physical, sensory or mental capabilities or lack of experience and knowledge can use this appliance only if they are supervised or have been given instructions on safe appliance use and if they understand the hazards involved. Children shall not play with the appliance. Cleaning and user maintenance shall not be made by children without supervision.
- During and after use, do not touch the heating elements or interior surfaces of the appliance - risk of burns. Do not allow the appliance to come into contact with cloths or other flammable materials until all the components have cooled down completely.
- At the end of cooking, exercise caution when opening the appliance door, letting the hot air or steam exit gradually before accessing the oven. When the appliance door is shut, hot air is vented from the aperture above the control panel. Do not obstruct the vent apertures.
- Use oven gloves to remove pans and accessories, taking care not to touch the heating elements.
- Do not place flammable materials in or near the appliance: a fire may break out if the appliance is inadvertently switched on.
- Do not heat or cook sealed jars or containers in the appliance. The pressure that builds up inside might cause the jar to explode, damaging the appliance.
- Do not use containers made of synthetic materials.
- Overheated oils and fats catch fire easily. Always remain vigilant when cooking foods rich in fat and oil.
- Never leave the appliance unattended during food drying.
- If alcoholic beverages are used when cooking foods (e.g. rum, cognac, wine), remember that alcohol evaporates at high temperatures. As a result, there is a risk that vapours released by the alcohol may catch fire upon coming into contact with the electrical heating element.
- Never use steam cleaning equipment.
- Do not touch the oven during the pyrolysis cycle. Keep children away from the oven during the pyrolysis cycle. Excess spillage must be removed from the oven cavity before cleaning cycle (only for ovens with Pyrolysis function).
- Only use the temperature probe recommended for this oven.
- Do not use harsh abrasive cleaners or sharp metal scrapers to clean the oven door glass since they can scratch the surface, which may result in shattering of the glass.

- Ensure that the appliance is switched off before replacing the lamp to avoid the possibility of electric shock.
- Do not use aluminium foil to cover food in the cooking vessel (only for ovens with cooking vessel supplied).

### **Scrapping of household appliances**

- This appliance is manufactured with recyclable or reusable materials. Dispose of it in accordance with local waste disposal regulations. Before scrapping, cut off the power supply cable.
- For further information on the treatment, recovery and recycling of household electrical appliances, contact your competent local authority, the collection service for household waste or the store where you purchased the appliance.

## **INSTALLATION**

After unpacking the oven, be sure that it has not been damaged during transport and that the oven door closes properly. In the event of problems, contact the dealer or your nearest After-sales Service. To avoid any damage, only remove the oven from its polystyrene foam base at the time of installation.

### **PREPARING THE HOUSING UNIT**

- Kitchen units in contact with the oven must be heat resistant (min 90°C).
- Carry out all cabinet cutting work before fitting the oven in the housing and carefully remove all wood chips and sawdust.
- After installation, the bottom of the oven must no longer be accessible.
- For correct appliance operation, do not obstruct the minimum gap between the worktop and the upper edge of the oven.

### **ELECTRICAL CONNECTION**

Be sure the power voltage specified on the appliance dataplate is the same as the mains voltage. The dataplate is on the front edge of the oven (visible when the door is open).

- Power cable replacement (type H05 RR-F 3 x 1.5 mm<sup>2</sup>) must be carried out by a qualified electrician. Contact an authorized service centre.

### **GENERAL RECOMMENDATIONS**

#### **Before use:**

- Remove cardboard protection pieces, protective film and adhesive labels from accessories.
- Remove the accessories from the oven and heat it at 200° for about an hour to eliminate the smell and fumes from the insulating materials and protective grease.

#### **During use:**

- Do not place heavy objects on the door as they could damage it.
- Do not cling to the door or hang anything from the handle.
- Do not cover the inside of the oven with aluminium foil.
- Do not pour water into the inside of a hot oven; this could damage the enamel coating.
- Do not drag pots or pans across the bottom of the oven as this could damage the enamel coating.
- Be sure that the electrical cables of other appliances do not touch hot parts of the oven or become trapped in the door.
- Do not expose the oven to atmospheric agents.

## **SAFEGUARDING THE ENVIRONMENT**



### **Disposal of packing material**

The packing material is 100% recyclable and is marked with the recycle symbol (♻️). The various parts of the packing must therefore be disposed of responsibly and in full compliance with local authority regulations governing waste disposal.

### **Scrapping the product**

- This appliance is marked in compliance with European Directive 2012/19/EU, Waste Electrical and Electronic Equipment (WEEE).
- By ensuring this product is disposed of correctly, you will help avoid potential negative consequences for the environment and human health, which could otherwise be caused by inappropriate waste handling of this product.
- The symbol  on the product or on the accompanying documentation indicates that it should not be treated as domestic waste but must be taken to an appropriate collection centre for the recycling of electrical and electronic equipment.

### **Energy saving tips**

- Only pre-heat the oven if specified in the cooking table or your recipe.
- Use dark lacquered or enamelled baking moulds as they absorb heat far better.

## **ECO DESIGN DECLARATION**

- This appliance meets the eco design requirements of European regulations n. 65/2014 and n. 66/2014 in conformity to the European standard EN 60350-1.

## TROUBLESHOOTING GUIDE

### The oven does not work:

- Check for the presence of mains electrical power and if the oven is connected to the electrical supply.
- Turn off the oven and restart it to see if the fault persists.

### The door will not open:

- Turn off the oven and restart it to see if the fault persists.
- **Important:** during self-cleaning, the oven door will not open. Wait until it unlocks automatically (see paragraph "Cleaning cycle of ovens with pyrolysis function").

### The electronic programmer does not work:

- If the display shows the letter "F" followed by a number, contact your nearest After-sales Service. Specify in this case the number that follows the letter "F".

## AFTER-SALES SERVICE

### Before calling the After-Sales Service:

1. See if you can solve the problem yourself with the help of the suggestions given in the "Troubleshooting guide".
2. Switch the appliance off and back on again to see if the fault persists.

### **If after the above checks the fault still occurs, get in touch with the nearest After-sales Service.**

Always specify:

- a brief description of the fault;
- the type and exact model of the oven;
- the service number (number after the word Service on the rating plate), located on the right hand edge of the oven cavity (visible when the oven door is open).  
The service number is also indicated on the guarantee booklet;
- your full address;
- your telephone number.

## SERVICE



If any repairs are required, please contact an authorised **After-sales Service** (to guarantee that original spare parts will be used and repairs carried out correctly).

## CLEANING



### WARNING

- **Do not use steam cleaning equipment.**
- **Clean the oven only when it is cool.**
- **Disconnect power before servicing.**

### Oven exterior

**IMPORTANT: do not use corrosive or abrasive detergents. If any of these products unintentionally comes into contact with the appliance, clean immediately with a damp microfibre cloth.**

- Clean the surfaces with a damp microfibre cloth. If it is very dirty, add a few drops of washing up detergent to the water. Finish off with a dry cloth.

### Oven interior

**IMPORTANT: do not use abrasive sponges or metallic scrapers or scourers. Over time, these can ruin enamelled surfaces and the oven door glass.**

- After every use, allow the oven to cool then clean it preferably while it is still warm in order to remove built-up dirt and stains caused by food residues (e.g. food with a high sugar content).
- Use proprietary oven detergents and follow the manufacturer's instructions to the letter.
- Clean the door glass with a suitable liquid detergent. The oven door can be removed to facilitate cleaning (see MAINTENANCE).
- The top heating element of the grill (see MAINTENANCE) can be lowered (some models only) to clean the roof of the oven.

**N.B.: during prolonged cooking of foods with a high water content (e.g. pizza, vegetables, etc.) condensation may form on the inside of the door and around the seal. When the oven is cold, dry the inside of the door with a cloth or sponge.**

### Accessories:

- Soak the accessories in water with washing up detergent immediately after use, handling them with oven gloves if still hot.
- Food residues can be easily removed using a brush or sponge.

### Cleaning the rear wall and catalytic side panels of the oven (if present):

**IMPORTANT: do not use corrosive or abrasive detergents, coarse brushes, pot scourers or oven sprays which could damage the catalytic surface and ruin its self-cleaning properties.**

- Operate the oven empty with the fan-assisted function at 200°C for about one hour
- Next, leave the appliance to cool down before removing any food residue with a sponge.

## MAINTENANCE

### **WARNING**

- Use protective gloves.
- Ensure the oven is cold before carrying out the following operations.
- Disconnect power before servicing.

#### **REMOVING THE DOOR**

##### **To remove the door:**

1. Open the door fully.
2. Lift the catches and push them forwards as far as they will go (fig. 1).
3. Close the door as far as it will go (A), lift it up (B) and turn it (C) until it is released (D) (fig. 2).

##### **To refit the door:**

1. Insert the hinges in their seats.
2. Open the door fully.
3. Lower the two catches.
4. Close the door.

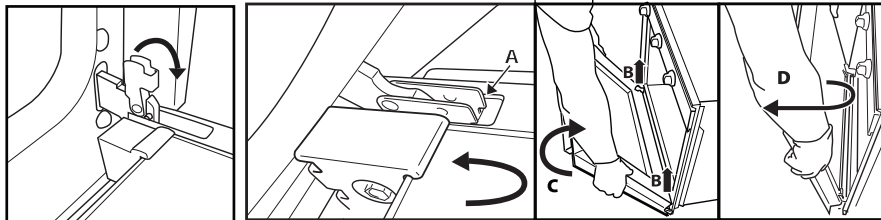

Fig. 1

Fig. 2

#### **MOVING THE TOP HEATING ELEMENT (SOME MODELS ONLY)**

1. Remove the side accessory holder grilles (Fig. 3).
2. Pull the heating element out a little (Fig. 4) and lower it (Fig. 5).
3. To reposition the heating element, lift it up, pulling it slightly towards you, be sure it comes to rest on the lateral supports.

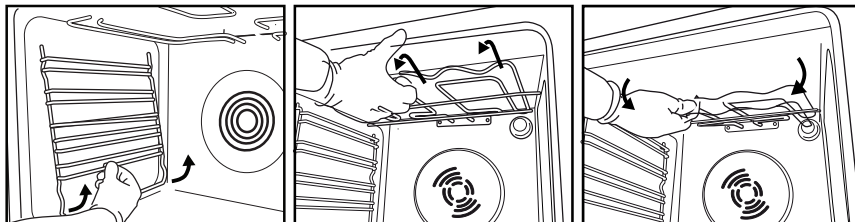

Fig. 3

Fig. 4

Fig. 5

#### **REPLACING THE OVEN LAMP**

##### **To replace the rear lamp (if present):**

1. Disconnect the oven from the power supply.
2. Unscrew the lamp cover (Fig. 6), replace the lamp (see note for lamp type) and screw the lamp cover back on (Fig. 7).
3. Reconnect the oven to the power supply.



Fig. 6

Fig. 7

##### **N.B.:**

- Only use 25-40W/230V type E-14, T300°C incandescent lamps, or 20-40W/230 V type G9, T300°C halogen lamps (depending on model).
- The lamp used in the appliance is specifically designed for electrical appliances and is not suitable for household room illumination (Commission Regulation (EC) No 244/2009).
- Lamps are available from our After-sales Service.

##### **IMPORTANT:**

- **If using halogen lamps, do not handle with bare hands since fingerprints can damage them.**
- **Do not use the oven until the lamp cover has been repositioned.**

# INSTRUCTIONS FOR OVEN USE

FOR ELECTRICAL CONNECTION, SEE THE PARAGRAPH ON INSTALLATION

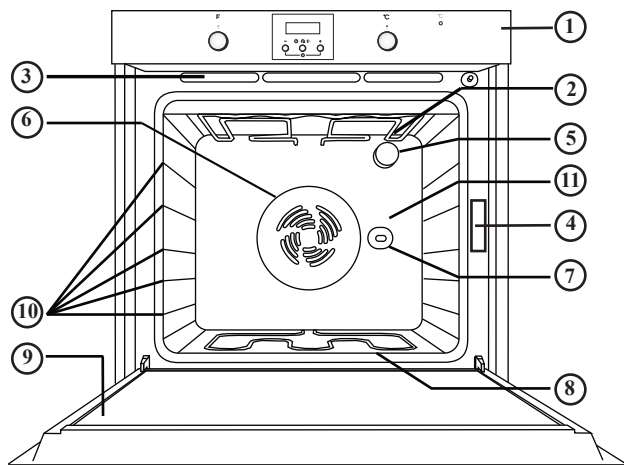

1. Control panel
2. Upper heating element/grill
3. Cooling system (if present)
4. Dataplate (not to be removed)
5. Light
6. Baking ventilation system (if present)
7. Turnspit (if present)
8. Lower heating element (not visible)
9. Door
10. Position of shelves
11. Rear wall

**N.B.:**

- At the end of cooking, after the oven has been switched off, the cooling fan may continue to run for a while.
- Your product may appear slightly different from the drawing.



## COMPATIBLE ACCESSORIES

(for the accessories supplied with oven refer to the tech fiche)

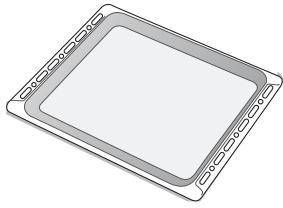

Fig. 1

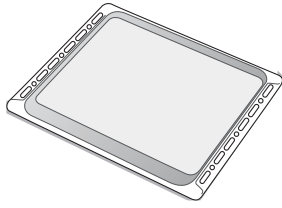

Fig. 2

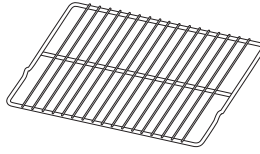

Fig. 3

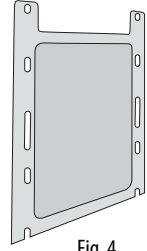

Fig. 4

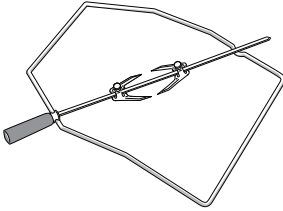

Fig. 5

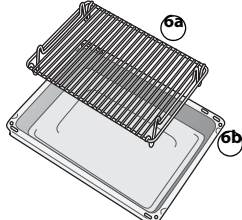

Fig. 6

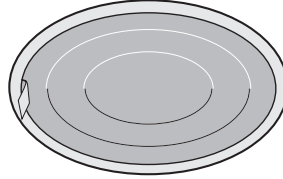

Fig. 7

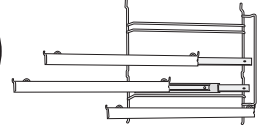

Fig. 8

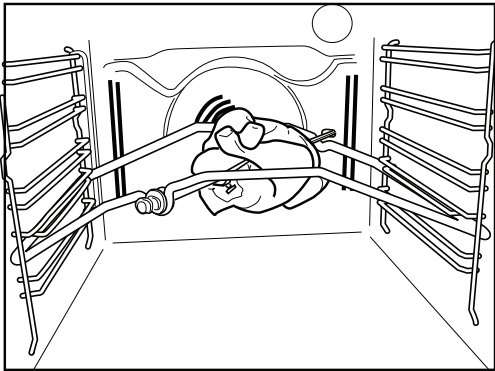

Fig. 9

### **Drip-tray (Fig. 1)**

For collecting fat and bits of food when placed under the wire shelf, or as a plate for cooking meat, chicken and fish, etc., with or without vegetables. Pour a little water into the drip-tray to avoid spatters of fat and smoke.

### **Baking tray (Fig. 2)**

For baking biscuits, cakes and pizzas.

### **Wire shelf (Fig. 3)**

For grilling food or as a support for pots, cake tins and other cooking receptacle. It can be placed on any available level. The wire shelf can be inserted with its curvature facing up or down.

### **Catalytic side panels (Fig. 4)**

These panels have a special microporous enamel coating that absorbs fat spatters. It is advisable to do an automatic cleaning cycle after cooking particularly fatty food (see CLEANING). **Turnspit (Fig. 5)**

Use the turnspit as indicated on Fig. 9. Also check "Recommended use and tips" section for advice.

### **Grill Pan Set (Fig. 6)**

The set comprises a wire shelf (6a) and an enameled recipient (6b). This set must be placed on the wire shelf (3) and used with the Grill function.

### **Grease filter (Fig. 7)**

Use **only** for particularly greasy cooking. Hook it on the rear wall of the oven compartment, opposite the fan. It can be cleaned in a dishwasher and used with the fan-assisted function.

### **Sliding shelves (Fig. 8)**

They allow the wire shelves and drip-trays to be pulled half out during cooking. Suitable for all the accessories, they can be cleaned in a dishwasher.

## CONTROL PANEL DESCRIPTION

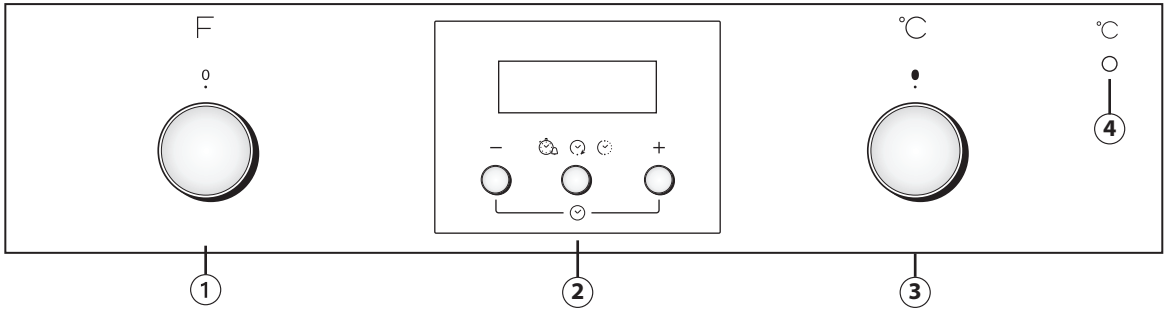

If knobs on your oven are retractable, push them in the middle and they pop up - depending on model. Your product may appear slightly different from the drawing.

1. Function selector knob
2. Electronic programmer
3. Thermostat knob
4. Red thermostat led.

## HOW TO OPERATE THE OVEN

- Turn the selector knob to the required function. The oven light switches on.
- Turn the thermostat knob clockwise to the required temperature. The thermostat led lights up, switching off again when the oven reaches the selected temperature.

At the end of cooking, turn the knobs to "0".

## USING THE ELECTRONIC PROGRAMMER

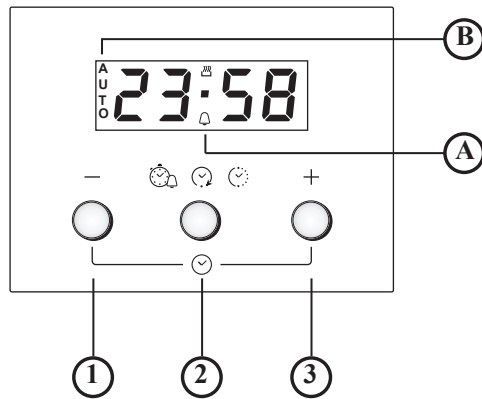

1. Button - : to decrease the value shown on the display
2. Button : for selecting the various settings:
  - a. Timer
  - b. Cooking time
  - c. Cooking end time setting
3. Button + : to increase the value shown on the display

**A.** The symbol indicates that the timer function is in operation

**B.** The **AUTO** symbol confirms the setting has been made

## Using the oven for the first time

Setting the time of day and the tone of the acoustic signal.

Upon connection of the oven to the mains power supply, **AUTO** and 0.00 flash on the display. To set the time of day, press buttons - and + at the same time: the central dot flashes. Set the time of day using the buttons + and -. Having selected the desired value, press the middle button. The display shows "ton 1". To select the desired tone, press button -. Having selected the preferred tone, press the middle button. To change the time of day, proceed as described above.



## Setting the timer

To set the timer, long-press the middle button: the display shows 0.00 and the bell symbol flashes. Set the timer using the button + (the maximum programmable value is 23 hours and 59 minutes). The countdown begins after a few seconds. The display shows the time of day and the bell remains lit, confirming the timer has been set. To view the countdown and change it if necessary, press the middle button again.











## Setting cooking time

After selecting the cooking mode and temperature using the knobs, press the middle button: the display shows 0.00 and the bell symbol flashes. Press the middle button again: on the display and 0.00 appear in sequence and **AUTO** flashes. Set cooking time using the buttons + and - (the maximum programmable value is 10 hours). After a few seconds the display shows the time of day and **AUTO** remains lit, confirming the setting. To view the remaining cooking time and change it if necessary, press the middle button for 2 seconds and then press it again a second time. At the end of the set time, the symbol switches off, the alarm sounds and **AUTO** flashes on the display. Press any button to deactivate the alarm. Return the functions and temperature knob to zero and press the middle button for two seconds to end cooking.

















## Delaying cooking end time



















After selecting cooking time, press the middle button: the display shows **End**, cooking end time and **AUTO** flashing in sequence. Press the button + to view the desired cooking end time (cooking can be delayed by a maximum of 23 hours and 59 minutes). After a few seconds the display shows the time of day, the symbol  switches off and **AUTO** remains lit, confirming the setting. To view cooking end time and change it if necessary, press the middle button and then press it again twice. At the end of the countdown, the symbol  lights up and the oven proceeds with the selected cooking mode.



## FUNCTION DESCRIPTION TABLE

FUNCTIONS KNOB		
	<b>OFF</b>	To stop cooking and switch off the oven.
	<b>LAMP</b>	To switch the oven light on/off.
	<b>CONVENTIONAL</b>	To cook any kind of dish on one shelf only. Use the 2nd shelf. Preheat the oven to the required temperature. The thermostat led turns off when the oven is ready and food can be placed in it.
	<b>SMARTCLEAN</b>	To eliminate the dirt created by cooking by means of a low temperature cycle. The combined action of the special enamel and the water vapour released during the cycle facilitates removal of grime. Activate the function when the oven is cold. Place 200ml of water in the bottom of the cavity, then run the cycle for 30 minutes at 90°C. At the end of the cycle, wait 15 minutes before opening the door.
	<b>CONVECTION BAKE</b>	To cook meat and pies with liquid filling (savory or sweet) on a single shelf, and pizzas on one or two shelves. This function delivers an even, golden, crisp top and base. When cooking on two levels, switch the position of the dishes halfway through cooking to cook food more evenly. Use the 2nd shelf to cook on one shelf only. To cook on two shelves, use the 1st and 3rd shelves. Preheat the oven to the required temperature and place the food in it when the set temperature is reached
	<b>GRILL</b>	To grill steak, kebabs and sausages; to cook vegetables au gratin and toast bread. Place food on the 4th shelf. When grilling meat, use the drip tray to collect the cooking juices. Position it on the 3rd shelf, adding approx. half a litre of water. Preheat the oven for 3-5 min. During cooking the oven door must remain closed.
	<b>TURBO GRILL</b>	To roast large joints of meat (legs, roast beef, chickens). Position the food on the middle shelves. Use the drip tray to collect the cooking juices. Position it on the 1st/2nd shelf, adding approx. half a litre of water. It is advisable to turn the meat over during cooking for more even browning. The oven does not have to be preheated. During cooking the oven door must remain closed. With this function you can also use the turnspit, if provided.
	<b>DEFROST</b>	To speed up defrosting of food. Place food on the middle shelf. Leave food in its packaging in order to prevent it from drying out on the outside.
	<b>TURBOFAN</b>	For food with a crisp base and soft top. Ideal for cooking cakes with liquid filling and no precooked base (e.g. tarts, plum cakes, ricotta cakes as well as pizzas with abundant topping) on a single shelf. Place food on the 2nd shelf. Preheat the oven before cooking. This function is also ideal for frozen convenience foods (e.g. pizzas, chips, strudel, lasagna). Follow the instructions on the product packaging.
	<b>FORCED AIR</b>	To cook a variety of food requiring the same temperature on two shelves at the same time (e.g. Fish, vegetables, cakes). This function can be used to cook different foods without odours being transferred from one food to another. Use the 2nd level to cook on one shelf only. To cook on two shelves, use the 1st and 3rd shelves after preheating the oven.
	<b>BOTTOM HEATING</b>	Use this function after cooking to brown the bottom of the dish. It is advisable to place the food on the 1st /2nd cooking level. The function can also be used for slow cooking, such as vegetables and meat stews; in this case use the 2nd cooking level. The oven does not have to be preheated.

## COOKING TABLE

Recipe	Function	Preheating	Shelf (from bottom)	Temp. (°C)	Time (min)	Accessories and notes
Leavened cakes		Yes	2	160-180	35-55	Cake tin on wire shelf
		Yes	1-3	150-170	30-90	Shelf 3: cake tin on wire shelf Shelf 1: cake tin on wire shelf
Filled pies (cheesecake, strudel, apple pie)		Yes	2	150-190	30-85	Drip tray/ baking tray or cake tin on wire shelf
		Yes	1-3	150-190	35-90	Shelf 3: cake tin on wire shelf Shelf 1: cake tin on wire shelf
Biscuits/Tartlets		Yes	3	170-180	15-40	Drip tray / baking tray
		Yes	1-3	150-175	20-45	Shelf 3: wire shelf Shelf 1: drip tray / baking tray
Choux buns		Yes	3	180	30-40	Drip tray / baking tray
		Yes	1-3	170-190	35-45	Shelf 3: oven tray on wire shelf Shelf 1: drip tray / baking tray
Meringues		Yes	3	90	120-130	Drip tray / baking tray
		Yes	1-3	90	130-150	Shelf 3: oven tray on wire shelf Shelf 1: drip tray / baking tray
Bread / Pizza / Focaccia		Yes	2	190-250	15-50	Drip tray / baking tray
		Yes	1-3	190-250	25-50	Shelf 3: oven tray on wire shelf Shelf 1: drip tray / baking tray
Frozen pizza		Yes	2	250	10-15	Shelf 2: drip tray / baking tray or wire shelf
		Yes	1-3	250	10-20	Shelf 3: oven tray on wire shelf Shelf 1: drip tray / baking tray
Savoury pies (vegetable pie, quiche lorraine)		Yes	2	175-200	40-50	cake tin on wire shelf
		Yes	1-3	175-190	50-65	Shelf 3: cake tin on wire shelf Shelf 1: cake tin on wire shelf

Recipe	Function	Preheating	Shelf (from bottom)	Temp. (°C)	Time (min)	Accessories and notes
Vols-au-vent / Puff pastry crackers		Yes	3	180-200	20-30	Drip tray / baking tray
		Yes	1-3	175-200	25-45	Shelf 3: oven tray on wire shelf Shelf 1: drip tray / baking tray
Lasagne / Baked pasta / Cannelloni / Flans		Yes	2	190-200	40-65	Drip tray or oven tray on wire shelf
Lamb / Veal / Beef / Pork 1 Kg		Yes	2	190-200	90-110	Drip tray or oven tray on wire shelf
Chicken / Rabbit / Duck 1 Kg		Yes	2	190-200	65-85	Drip tray or oven tray on wire shelf
Turkey / Goose 3 Kg		Yes	1/2	190-200	140-180	Drip tray or oven tray on wire shelf
Baked fish / en papillote (fillet, whole)		Yes	2	180-200	40-60	Drip tray or oven tray on wire shelf
Stuffed vegetables (tomatoes, courgettes, aubergines)		Yes	2	175-200	50-60	Oven tray on wire shelf
Toast		Yes	4	200	2-5	wire shelf
Fish fillets / steaks		Yes	4	200	30-40	Shelf 4: wire shelf (turn food halfway through cooking)
						Shelf 3: drip tray with water
Sausages / Kebabs / Spare ribs / Hamburgers		Yes	4	200	30-50	Shelf 4: wire shelf (turn food halfway through cooking)
						Shelf 3: drip tray with water
Roast chicken 1-1.3 Kg		-	2	200	55-70	Shelf 2: wire shelf (turn food two thirds of the way through cooking if necessary)
						Shelf 1: drip tray with water
Roast chicken 1-1.3 Kg		-	2	200	60-80	Shelf 2: turnspit (if present)
						Shelf 1: drip tray with water
Roast Beef rare 1 Kg		-	2	200	35-50	Oven tray on wire shelf (turn food two thirds of the way through cooking if necessary)
Leg of lamb / Shanks		-	2	200	60-90	Drip tray or oven tray on wire shelf (turn food two thirds of the way through cooking if necessary)
Roast potatoes		-	2	200	45-55	Drip tray / baking tray (turn food two thirds of the way through cooking if necessary)
Vegetable gratin		-	2	200	20-30	Oven tray on wire shelf
Lasagna & Meat		Yes	1-3	200	50-100*	Shelf 3: oven tray on wire shelf
						Shelf 1: drip tray or oven tray on wire shelf

Recipe	Function	Preheating	Shelf (from bottom)	Temp. (°C)	Time (min)	Accessories and notes
Meat & Potatoes		Yes	1-3	200	45-100*	Shelf 3: oven tray on wire shelf
						Shelf 1: drip tray or oven tray on wire shelf
Fish & Vegetables		Yes	1-3	175	30-50*	Shelf 3: oven tray on wire shelf
						Shelf 1: drip tray or oven tray on wire shelf

The times given in the table are for cooking done with delayed start mode (if available). Cooking times may be longer, depending on the dish.

**N.B.:** the cooking function symbols can be slightly different from the drawing.

**N.B.:** cooking times and temperatures are approximate for 4 portions.

## RECOMMENDED USE AND TIPS

### How to read the cooking table

The table indicates the best function to use for any given food, to be cooked on one or more shelves at the same time. Cooking times start from the moment food is placed in the oven, excluding pre-heating (where required). Cooking temperatures and times are purely for guidance and will depend on the amount of food and type of accessory used. Use the lowest recommended values to begin with and, if the food is not cooked enough, then move on to higher values. Use the accessories supplied and preferably dark coloured metal cake tins and oven trays. You can also use pans and accessories in pyrex or stoneware, but bear in mind that cooking times will be slightly longer. To obtain best results, carefully follow the advice given in the cooking table for the choice of accessories (supplied) to be placed on the various shelves.

#### Cooking different foods at the same time

Using the "FORCED AIR" function, you can cook different foods which require the same cooking temperature at the same time (for example: fish and vegetables), using different shelves. Remove the food which requires less cooking time and leave food which requires longer cooking time in the oven.

#### Desserts

- Cook delicate desserts with the conventional function on one shelf only. Use dark coloured metal cake tins and always position them on the wire shelf supplied. To cook on more than one shelf, select the forced air function and stagger the position of the cake tins on the shelves, aiding optimum circulation of the hot air.
- To check whether a raising cake is cooked, insert a wooden toothpick into the centre of the cake. If the toothpick comes out clean, the cake is ready.
- If using non-stick cake tins, do not butter the edges as the cake may not rise evenly around the edges.
- If the cake "sinks" during cooking, set a lower temperature the next time, perhaps reducing the amount of liquid in the mixture and mixing more gently.
- For sweets with moist fillings (cheesecake or fruit pies) use the "CONVECTION BAKE" function. If the base of the cake is soggy, lower the shelf and sprinkle the bottom of the cake with breadcrumbs or biscuit crumbs before adding the filling.

#### Meat

- Use any kind of oven tray or pyrex dish suited to the size of the piece of meat being cooked. For roast joints, it is best to add some stock to the bottom of the dish, basting the meat during cooking for added flavour. When the roast is ready, let it rest in the oven for another 10-15 minutes, or wrap it in aluminium foil.
- When you want to grill meat, choose cuts with an even thickness all over in order to achieve uniform cooking results. Very thick pieces of meat require longer cooking times. To prevent the meat from burning on the outside, lower the position of the wire shelf, keeping the food farther away from the grill. Turn the meat two thirds of the way through cooking.

To collect the cooking juices it is advisable to place a drip-tray with half a litre of water directly under the grill on which the meat is placed. Top-up when necessary.

#### Turnspit (only in some models)

Use this accessory to evenly roast large pieces of meat and poultry. Place the meat on the turnspit rod, tying it with string if chicken, and check that it is secure before inserting the rod in the seat located on the front wall of the oven and resting it on the respective support. To prevent smoke and to collect cooking juices, it is advisable to place a drip-tray with half a litre of water on the first level. The rod has a plastic handle which must be removed before starting to cook, and used at the end of cooking to avoid burns when taking the food out of the oven.

#### Pizza

Lightly grease the trays to ensure the pizza has a crispy base. Scatter the mozzarella over the pizza two thirds of the way through cooking.



03/2016



400011511029



Whirlpool is a registered trademark of Whirlpool, USA